

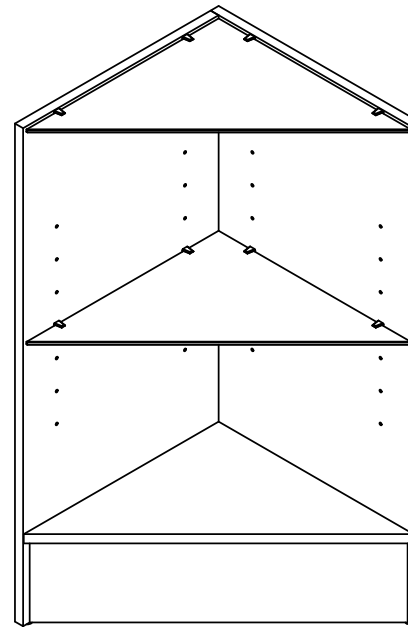

GRAND + BENEDICTS

ASSEMBLY
INSTRUCTIONS

OPEN CORNER UNIT :: 260-EC-OCD



PART LIST:

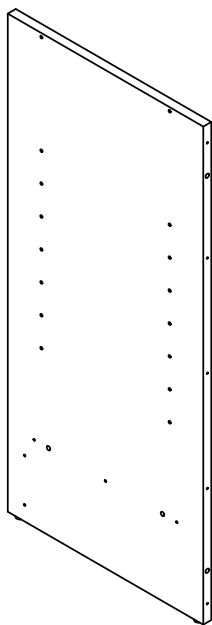

1X. LEFT SIDE PANEL

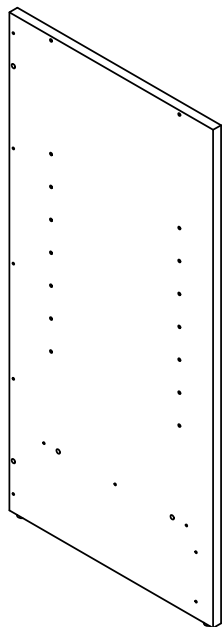

1X. RIGHT SIDE PANEL

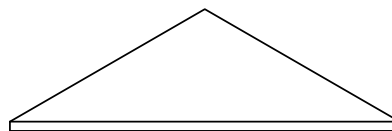

1X. BOTTOM PANEL

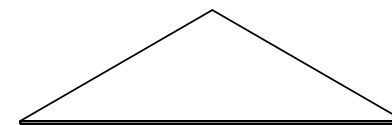

2X. GLASS SHELF

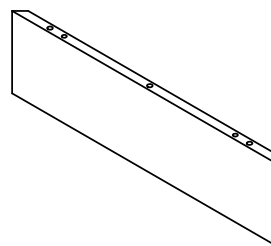

1X. TOE KICK

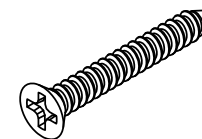

15X. PHILLIPS FLAT HEAD SELF-TAPPING SCREW #8 X 1.5"

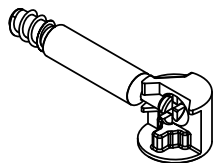

3X. CAMLOCK

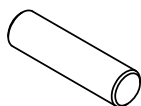

8X. WOOD DOWEL

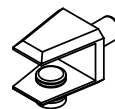

8X. SHELF CLIP

STEP 1:

1. SCREW THE BOLTS OF CAMLOCK & INSERT WOOD DOWELS INTO THE BOTTOM OF BOTTOM PANEL.
2. CONNECT THE TOE KICK BY CAMLOCKS.

- 1X. TOE KICK
- 1X. BOTTOM PANEL
- 3X. CAMLOCK
- 2X. WOOD DOWEL

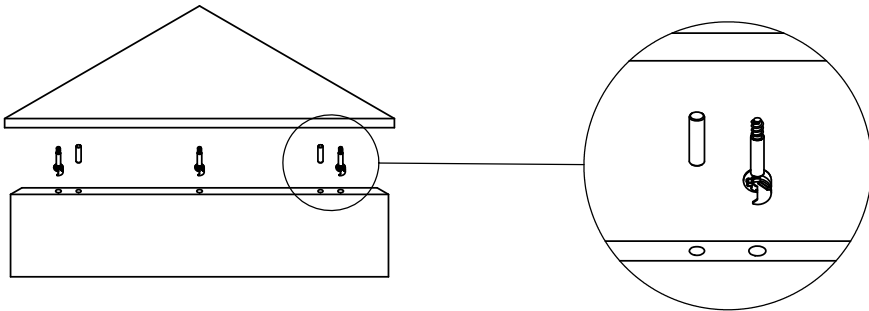

STEP 2:

1. INSERT WOOD DOWELS INTO BOTTOM PANEL & LEFT SIDE PANEL.
2. CONNECT LEFT & RIGHT SIDE PANEL & BASE WITH WOOD SCREWS.

- 1X. LEFT SIDE PANEL
- 1X. RIGHT SIDE PANEL
- 15X. PHILLIPS FLAT HEAD SELF-TAPPING SCREW #8 X 1.5"
- 6X. WOOD DOWEL

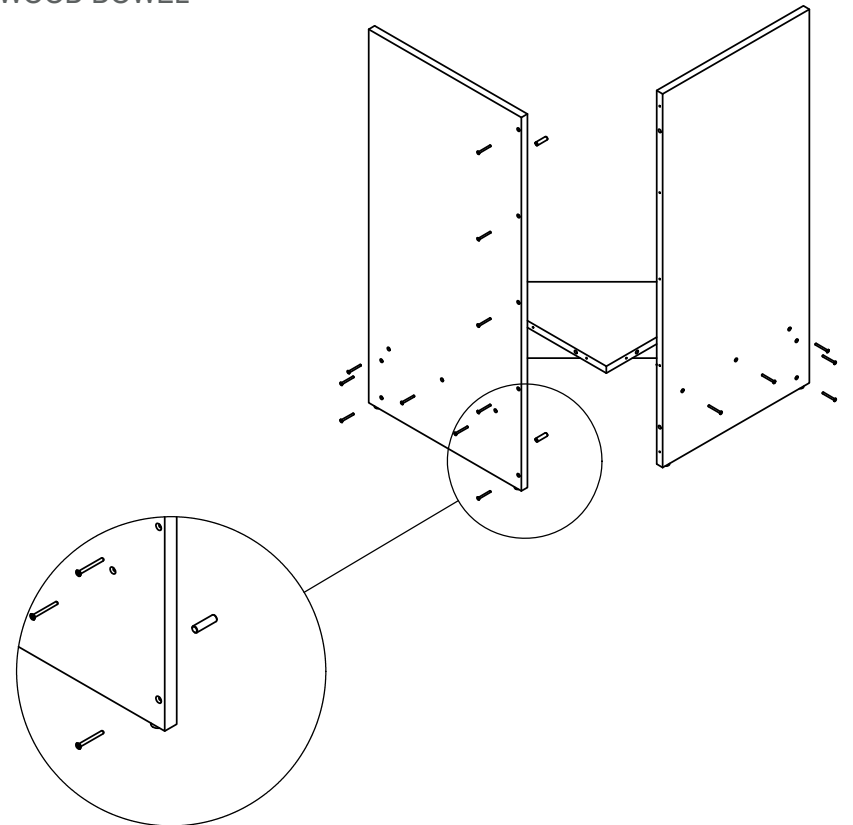

STEP 3:

1. INSERT THE SHELF CLIPS INTO SIDE PANELS.
2. INSERT GLASS SHELVES INTO SHELF CLIPS.
3. TIGHTEN GLASS CLIPS.

2X. GLASS SHELF
8X. SHELF CLIP

